

**vitra.**

**Nelson Collection**





**George Nelson**, an architect by training, was one of the most important and influential figures in American design. In addition to his work in the fields of architecture, product and exhibition design, he made a significant contribution to the international discourse on design and architecture over several decades with an extensive body of published writings.

**Vitra** has produced and marketed designs by Nelson since 1957, initially under license. In 1984, Vitra acquired exclusive rights for Europe and the Middle East. During the past few years, the Nelson Collection has been expanded by several additional objects. The Vitra label is your guarantee that the product you have purchased is a George Nelson original.



George Nelson, Charles Eames and Alexander Girard in an advertisement for Herman Miller Inc., c. 1960



Marshmallow Sofa, 1956



Coconut Chair, 1955

Photo of the 'Swag Leg Group' for a catalogue, 1964



**Coconut Chair** 1955



**Nelson Bench** 1946



**Nelson Perch** 1964



**Marshmallow Sofa** 1956



**Home Desk** 1958



**Nelson Tables** 1960



**Tray Table** 1949



**Classic Tray "China Shop"** 1950



**Wall Clocks** 1948/60 | **Desk Clocks** 1947/54  
**Ceramic Clocks** 1947/54 | **Zoo Timers** 1965





### Coconut Chair

The Coconut Chair (1955) was reintroduced by Vitra in 1988, and is a typical example of 1950s design. It is distinguished by its design purity and restrained use of materials. The comfortable leather or fabric upholstered seat is reminiscent of a coconut that has been cut open into eight identical pieces.



Sony Europe, Berlin (D)



### Nelson Bench

The clean straight lines of this bench reflect Nelson's architectural background. Reminiscent of Japanese furniture, it can function both as a bench and as an occasional table.



### Nelson Perch

The Nelson Perch (1964) is an ideal solution for a working position somewhere between standing and sitting. It is also useful for people who need to stand up in informal conference situations. Its armrest and ring-shaped footrest allow the user to adopt a comfortable position.



HUG AG, Malters (CH)

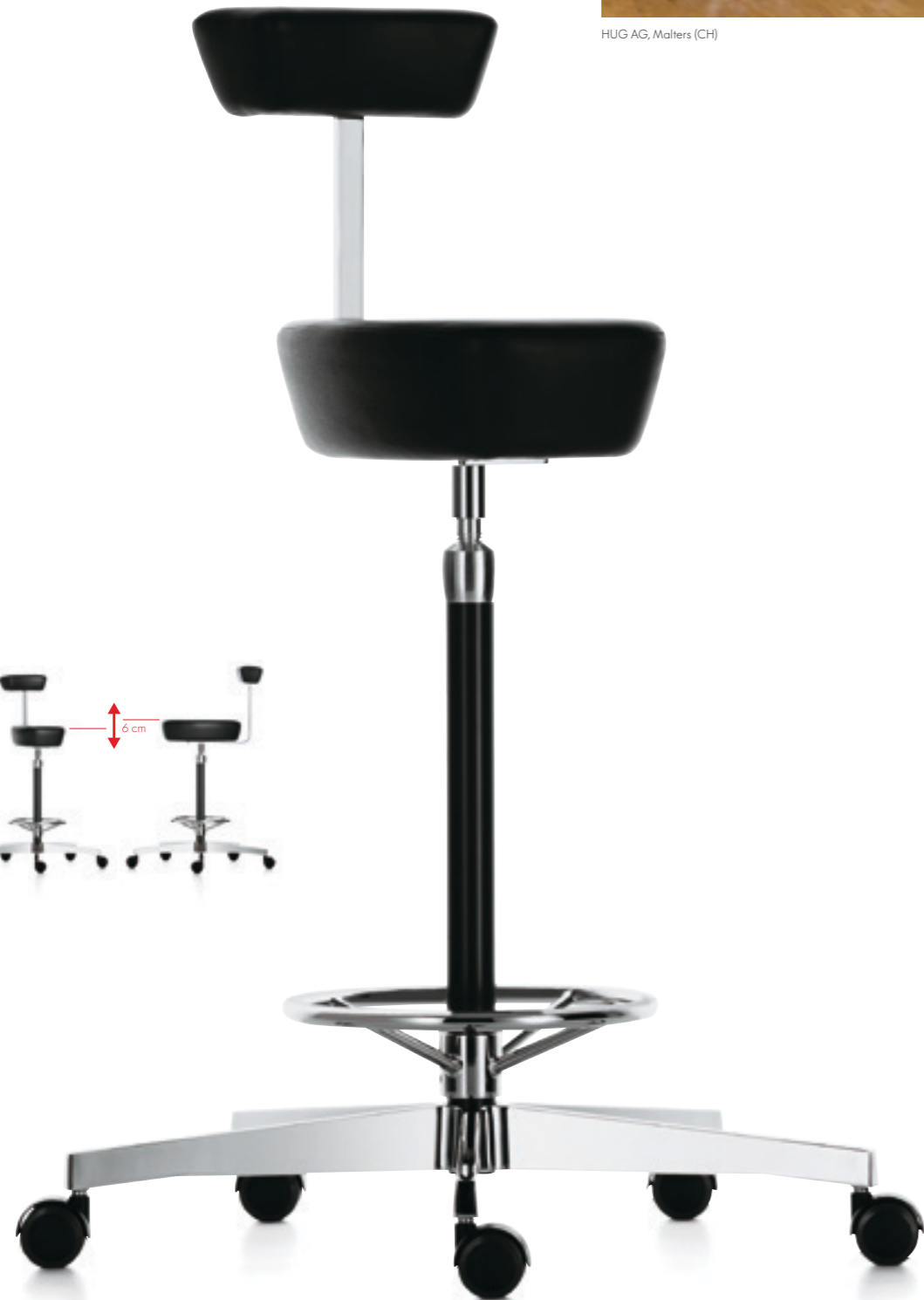

### Marshmallow Sofa

This sofa is one of the earliest examples of Pop Art in furniture design. Its unique form makes it one of the few truly unconventional sofas in design history. The basic version consists of 18 individual round cushions mounted on transverse braces in the seat and back. A connecting element makes it possible to join individual sofas together, extending the length as desired.



**Home Desk**

Due to its simple and yet decorative form, the Home Desk is a timeless classic. Originally designated as a 'Ladies Desk', it finds contemporary use primarily as a laptop workplace or side table. The coloured compartments in the rear wall offer storage space for small articles.





Telindus, Leuven (B)

**Nelson Tables**

An attention to details is characteristic of all George Nelson's designs and this quality is apparent in the tables' finishes. The table top edging is bevelled to highlight the birch ply. The tables are available in two sizes and heights.



**Tray Table**

Tray Table boasts a simple elegance as well as refined structural elements. Thanks to its simple height adjustment mechanism and the asymmetry of its design, the table can be placed directly next to an armchair, a sofa or even a bed. This makes Tray Table a faithful companion.



George Nelson



China Shop

Charles & Ray Eames



The Family



Sea Things

Alexander Girard



Eden



Millerstripe



Mother & Child

**Classic Trays**

The quality of the furnishings does not only manifest itself in large objects. Both the choice and the composition of the furniture, lighting and textiles are important for our sense of well-being at home. It's the small things – the various accessories, pictures, plants, mementos and occasional finds we have collected – that play a major role in our emotional attachment to the home. In recent decades only a few designers, such as Charles and Ray Eames, Alexander Girard and George Nelson, have been aware of this.

Starting with the same ideas in the mid twentieth century they created furnishings and objects in which small things always had an important place. It is with this thought in mind that the Classic Trays are now being brought onto the market by the Vitra Design Museum.



### Wall Clocks

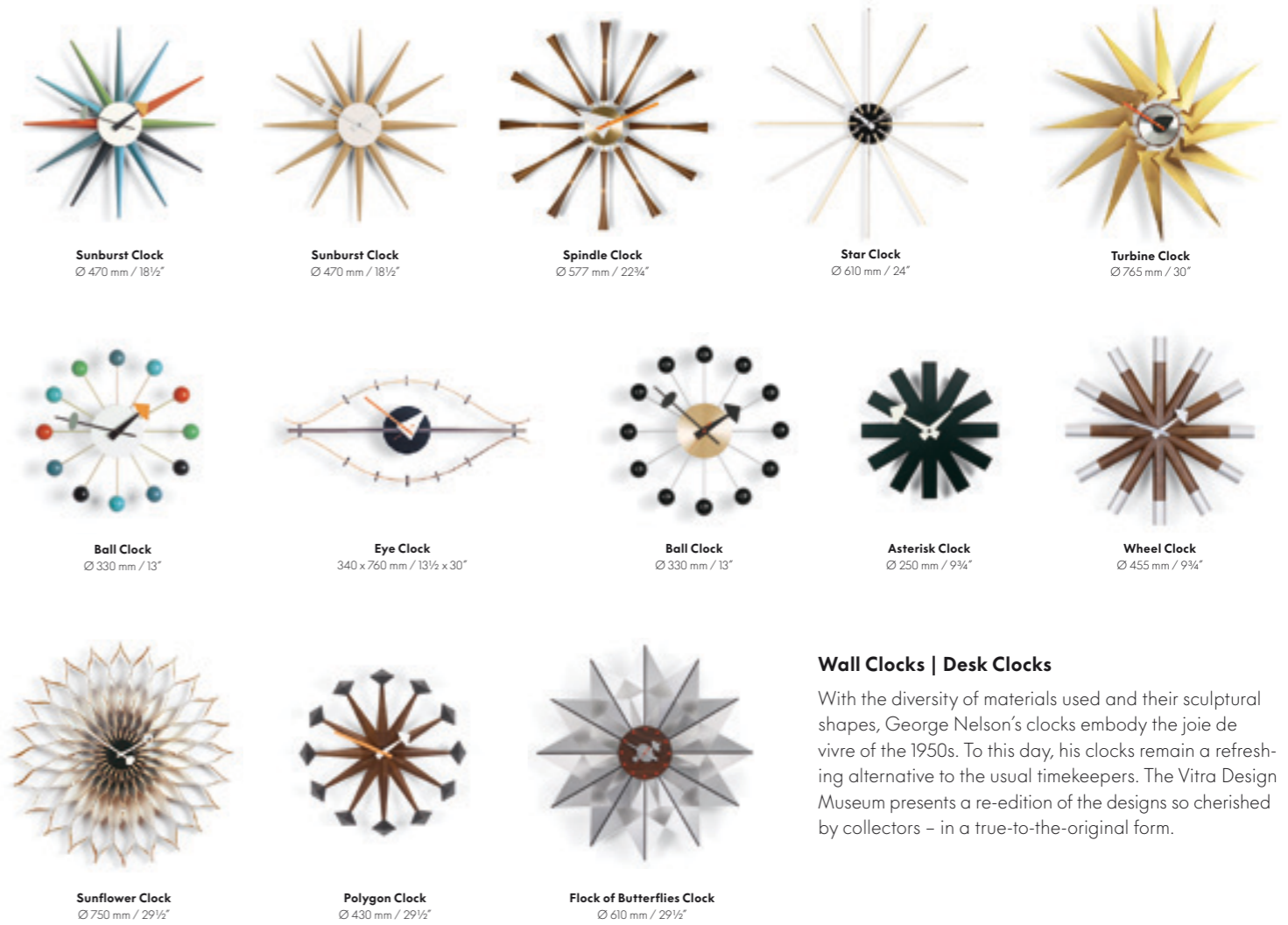

**Sunburst Clock**  
Ø 470 mm / 18½"

**Sunburst Clock**  
Ø 470 mm / 18½"

**Spindle Clock**  
Ø 577 mm / 22¾"

**Star Clock**  
Ø 610 mm / 24"

**Turbine Clock**  
Ø 765 mm / 30"

**Ball Clock**  
Ø 330 mm / 13"

**Eye Clock**  
340 x 760 mm / 13½ x 30"

**Ball Clock**  
Ø 330 mm / 13"

**Asterisk Clock**  
Ø 250 mm / 9¾"

**Wheel Clock**  
Ø 455 mm / 17¾"

**Sunflower Clock**  
Ø 750 mm / 29½"

**Polygon Clock**  
Ø 430 mm / 29½"

**Flock of Butterflies Clock**  
Ø 610 mm / 29½"

### Wall Clocks | Desk Clocks

With the diversity of materials used and their sculptural shapes, George Nelson's clocks embody the joie de vivre of the 1950s. To this day, his clocks remain a refreshing alternative to the usual timekeepers. The Vitra Design Museum presents a re-edition of the designs so cherished by collectors – in a true-to-the-original form.

### Desk Clocks

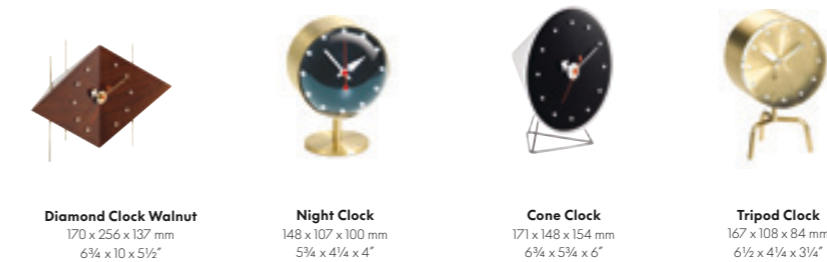

**Diamond Clock Walnut**  
170 x 256 x 137 mm  
6¾ x 10 x 5½"

**Night Clock**  
148 x 107 x 100 mm  
5¾ x 4¼ x 4"

**Cone Clock**  
171 x 148 x 154 mm  
6¾ x 5¾ x 6"

**Tripod Clock**  
167 x 108 x 84 mm  
6½ x 4¼ x 3¼"

### Zoo Timers

As a truly multi-talented designer, George Nelson was also successful as a graphic designer. Thanks to their graphic touch, his Zoo Timers – extremely colourful animal "personalities" – contrast sharply to his sculptural wall clocks from the 1950s. The Zoo Timers offer children a playful and enjoyable approach to telling the time.

### Zoo Timers



**Fernando the Fish**  
250 x 280 x 35 mm  
10 x 11 x 1¼"

**Omar the Owl**  
255 x 270 x 35 mm  
10 x 10½ x 1¼"

**Elihu the Elephant**  
320 x 320 x 50 mm  
12½ x 12½ x 2"

### Ceramic Clocks



**Model #1, red**  
320 x 320 x 83 mm  
7½ x 5 x 3¼"

**Model #2, white**  
224 x 152 x 88 mm  
8¾ x 6 x 3½"

**Model #3, grey**  
171 x 150 x 84 mm  
7½ x 6 x 3¼"

### Ceramic Clocks

The first eye-catching thing about the Ceramic Clocks is their playful design and their shape. These table clocks have a somewhat geometric yet organic look to them that is evocative of sculptures by artists such as Constantin Brancusi and Isamu Noguchi. The clock cases are entirely made of glazed ceramics. Both the colours used and the design of the clock faces are convincing functional features.

**Programme features**

**Coconut Chair**

Seat of white fibreglass reinforced plastic. Chromed steel base. One-piece leather or Hopsak cover upholstery.

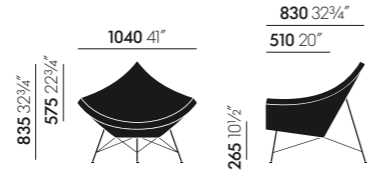

Coconut Chair

**Hopsak**

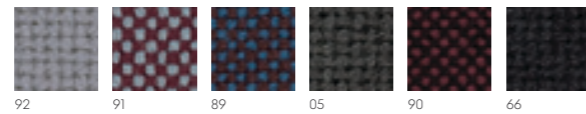
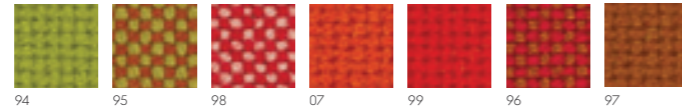

**Leather**

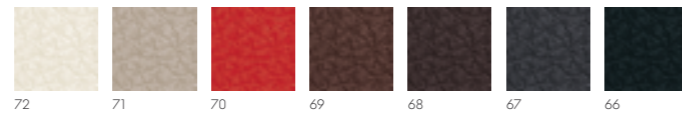

**Nelson Bench**

Natural ash wooden panels. Base also in ash, but varnished black.

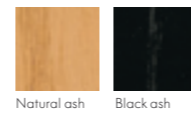
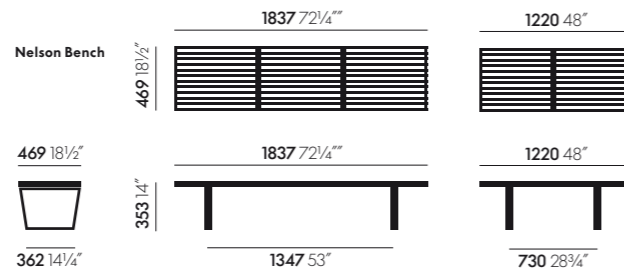

Nelson Perch



**Leather**

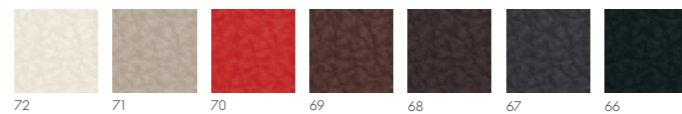

Marshmallow Sofa

**Vinyl**



Deviations in colour are possible due to the printing process.

All measurements in millimetres and inches

**Home Desk**

Table top and horizontal surfaces of white laminate (HPL) with wooden lipping in walnut veneer. Plastic drawer insert. Base frame made of butted alloy tubing, chrome plated.

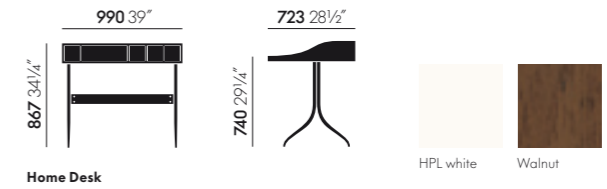

Home Desk

**Nelson Tables**

Table top in bevelled plywood veneered with black or white laminate with angled edging. Steel base. Table support and feet in cast aluminium. White or black epoxy coated with adjustable nylon glides.

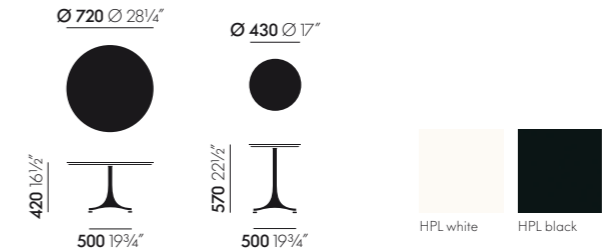

Nelson Tables

**Tray Table**

Plywood table top, chromed tubular steel base.

**Classic Tray**

High-grade thermoset plastic, dishwasher safe, food safe. 20 x 460 x 355 mm.

**Wall Clocks**

Lacquered wood and metal, high-grade quartz clockwork, incl. battery.

**Desk Clocks**

Lacquered wood and metal, high-grade quartz clockwork, incl. battery.

**Ceramic Clocks**

Glazed ceramics, high-grade quartz clockwork, incl. battery.



Tray Table

**Zoo Timers**

Wall clocks, multiple colour printing, high-grade quartz clockwork, incl. battery.





**vitra.**

Vitra is represented worldwide. To find a Vitra partner in your area, go to [www.vitra.com](http://www.vitra.com).  
2012, art. no. 091394 02

**vitra.**® All intellectual property rights, such as trademarks, patents and copyrights are reserved. Nothing shown on this printed matter may be reproduced without written permission.